

# ExpertLine

EL45x99A1x / EL45x74A1x / EL45x49A1x

**Short Guide** – Please refer to full assembly and mounting instructions

## 1 Cutting the ExpertLine contact profile to length

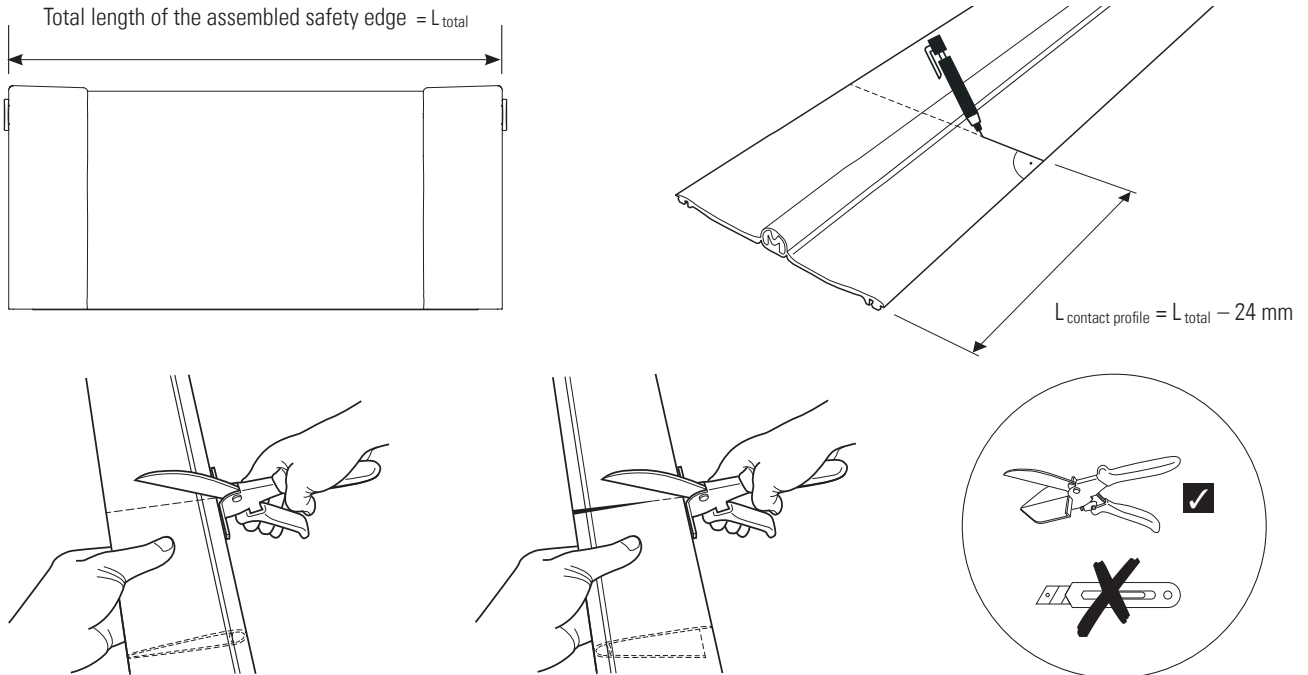

## 2 Mounting contact end pieces

**1**  
The sealant is highly adhesive; dust and dirt particles will stick to it immediately on contact. Therefore, proceed with particular care and ensure that the working environment is kept clean and tidy until it is pressed into place.

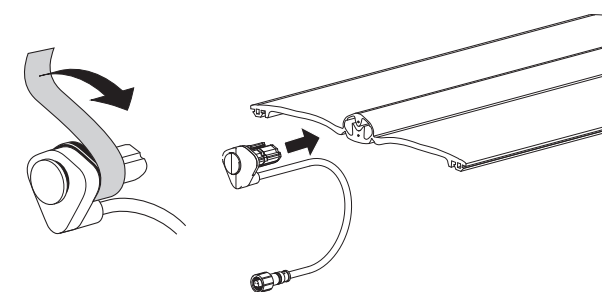

**2**  
Hold the profile shank at an acute angle and check for axial alignment when pressing the contact end piece in.

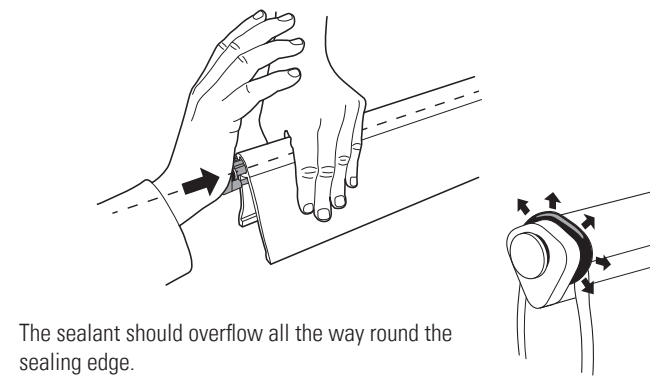

## 3 Intermediate check / Resistance measurement

Connect the resistor plug and the cable, actuate the sensor.

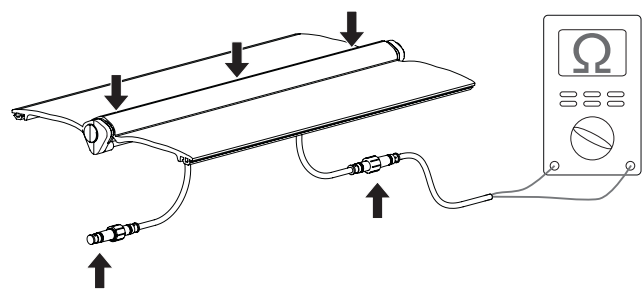

## 4 Mounting the contact profile onto the mounting profile

1

Fit the first side of the contact profile flush at both ends of the mounting profile and press it into the mounting profile, working from the ends towards the centre.

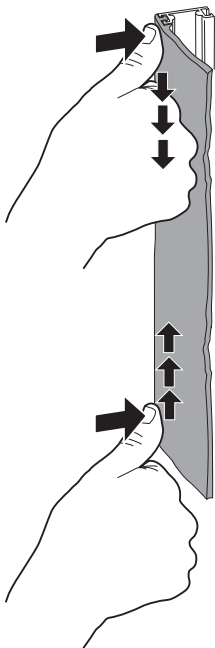

The rubber retainers must engage fully in the mounting profile.

**Tip:** Use a tool to help you to push the retainers in.

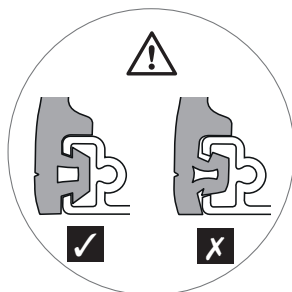

2

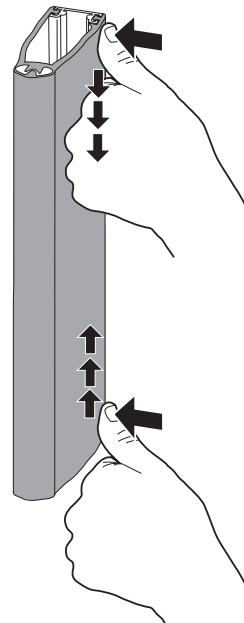

## 5 Mounting end caps

1

Turn out the end cap at the top.

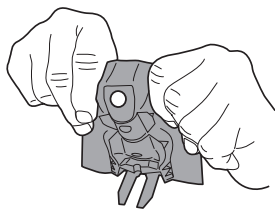

Prepare the lower end cap: remove the drainage stud.

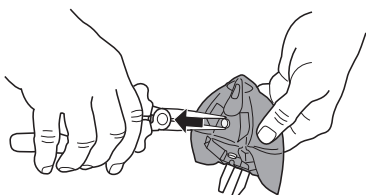

2

Pull the hole over the retainer on the contact end piece. Check for a tight fit from the outside.

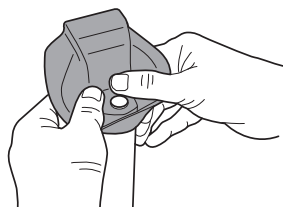

3

Turn out the end cap and position the end cap correctly.

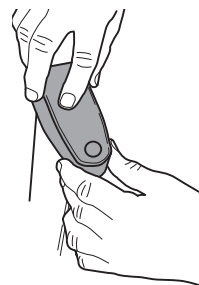

Push the fastening clip in as far as the stop.

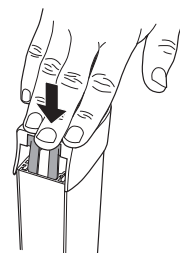

4

Correct end position.

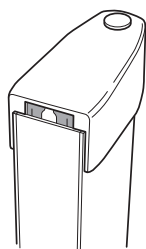

## 6 Contact

**BBC Bircher Smart Access**, BBC Bircher AG, Wiesengasse 20, CH-8222 Beringen, [www.bircher.com](http://www.bircher.com)