

ExpertLine

EL45x99A1x / EL45x74A1x / EL45x49A1x

简易指导：请参照完整的装配说明书

1 裁剪 ExpertLine 触边胶条

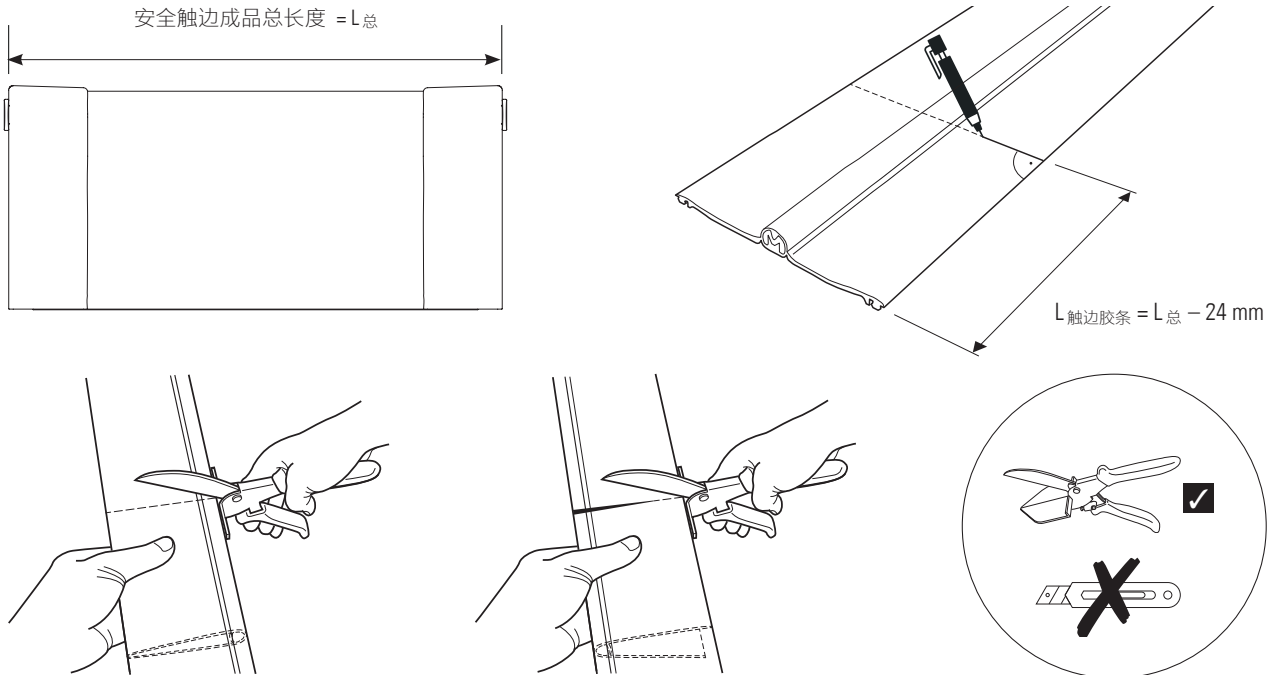

2 安装尾端件

1

密封剂具有高粘合力，灰尘和污垢颗粒在接触后会立即粘附。因此，打开包装和取下接触端头的保护盖后，必须特别小心和干净地操作，直至尾端件完全压上！

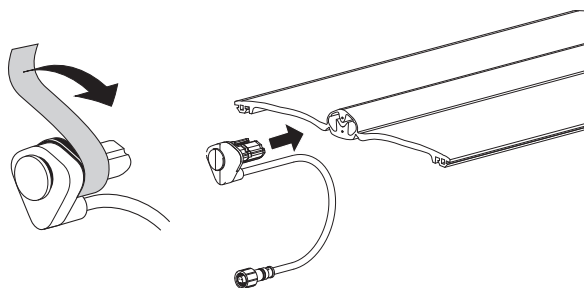

2

使型材支腿保持锐角并且在压入时注意轴向对齐！

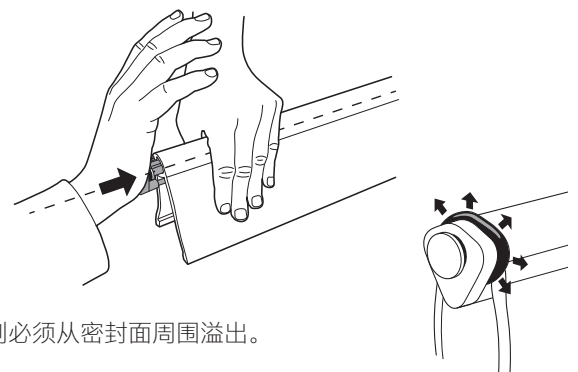

3 最终检测/电阻测量

连接电阻插头和电缆，按压安全触边

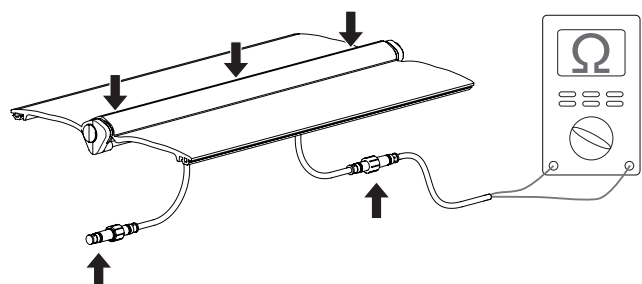

4 触边胶条安装到支撑型材上

1

先将安全触边一侧的两端用力压入铝型材，然后沿着两端向中间均匀压入胶条，直至将整根触边完全卡入铝型材中。

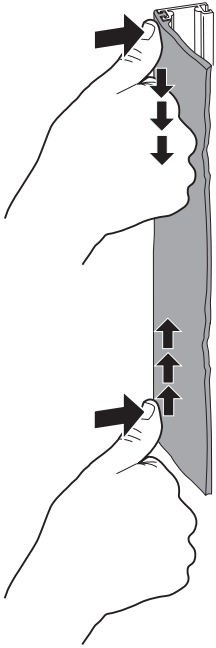

触边胶条的卡口必须完全卡入铝型材中。

提示：使用卡入辅助工具

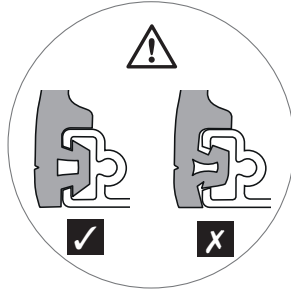

2

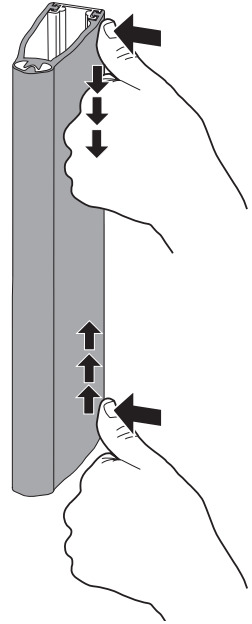

5 安装端盖

1

将端盖内侧翻出来

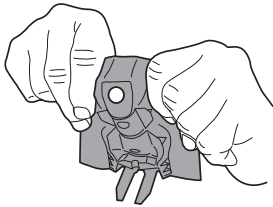

准备下部端盖：
取下排水堵头

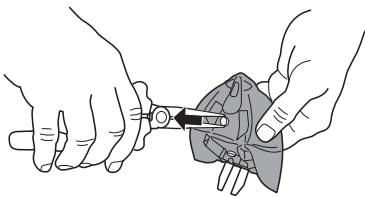

2

将孔套在接触端头的锁定凸头上。
检查外部的凸位置



3

翻下端盖
适当地定位端盖

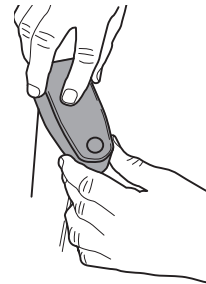

将固定夹压入到卡入位置

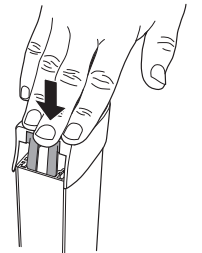

4

正确的尾端位置

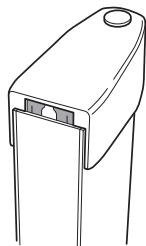

6 联系方式

BBC Bircher Smart Access, BBC Bircher AG, Wiesengasse 20, CH-8222 Beringen, www.bircher.com