

Safety mats

Electrical surface switches for safe activation and deactivation of machines, devices and automatic doors

Reliable, robust, low-maintenance

- System is simple to install
- Surface switch for convenience and safety applications
- Especially robust due to full potting
- Standard and customer-specific designs available

Safety mats

Safety mats for safety and comfort applications

Safety

The safety mats from Bircher are used for detecting people or objects within a defined area. In conjunction with the EsMatix 3 safety switching device, they form a certified system for safeguarding danger zones, and thus for protecting people.

Convenience

Safety mats are characterised by their sturdy construction. They are available in a range of different shapes and designs. Directly connected to a controller, they are used as a switching element for convenient application.

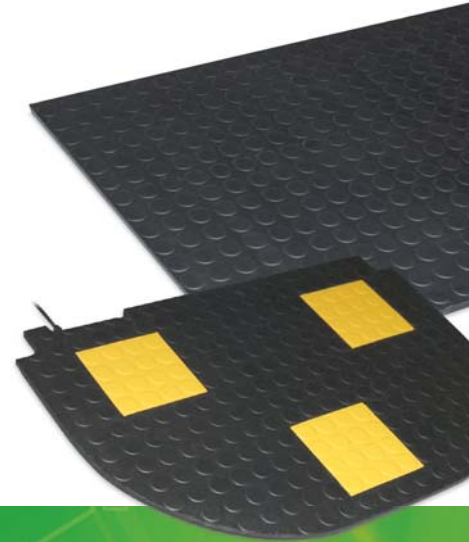

Benefits for you

Universally applicable

- Maintenance-free
- Tailor-made for your requirements
- Easy to install
- Clearly visible
- Diverse shapes possible
- Surface structures and hardnesses can be selected
- Several switching zones are possible on one surface
- Individual mats, small batches and mass production

Functional principle

When anyone steps on the surface of the mat, or a load is placed on it, two parallel contact surfaces are pressed together and the electrical circuit is made.

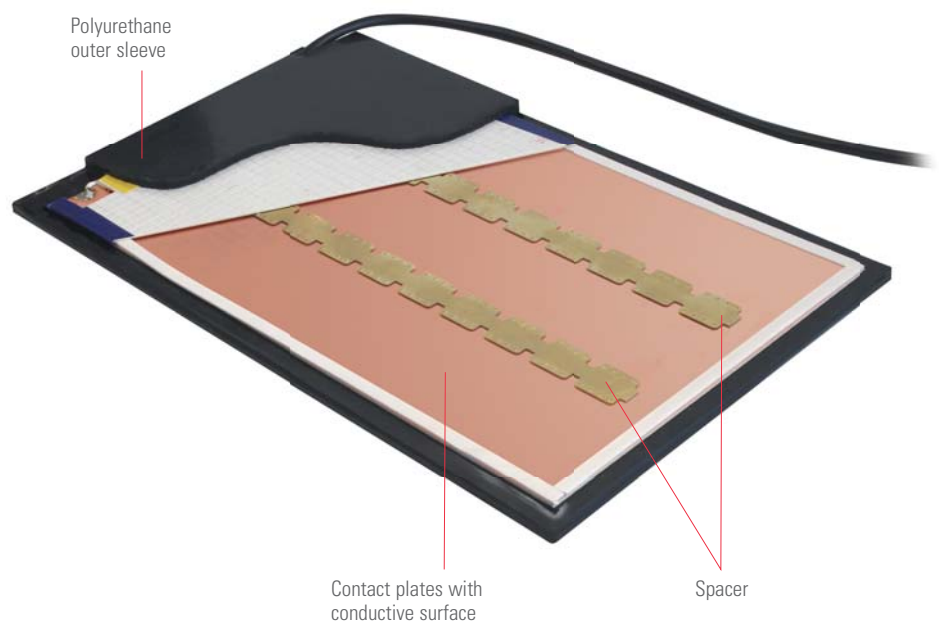



Safety switching device EsMatix 3

- Performance level PL e, cat. 3 acc. to EN ISO 13849-1, in combination with a safety mat from Bircher
- Two inputs for connecting several safety mats
- Redundant safety output
- Monitoring output
- Automatic or manual reset
- Installation on DIN rail

In combination with the EsMatix 3 safety switching device, the Bircher safety mat is type-tested acc. to EN ISO 13856-1.



Reliable in every application

ESM-52/54

Standard shapes

Situation

Danger of injury due to moving machine parts

Solution

- Switch off a machine in the danger area

Benefits

- Robust standing surface with integrated safety switch
- Clearly visible
- Can be combined to protect larger areas

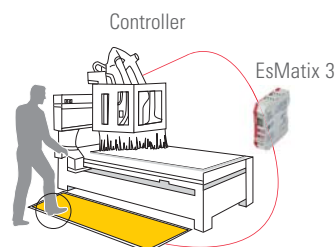

ESM-57

Special shapes

Situation

Automatic doors and locks

Solution

- Passage control and activation of revolving doors
- Individual passage at locks

Benefits

- Robust standing surface with integrated safety switch
- Several switching zones possible
- Individual shaping

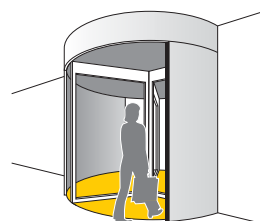

EMP

Forklift mats

Situation

Forklift trucks

Solution

- Deactivation in case of unplanned exit from the operating platform

Benefits

- Robust standing surface with integrated safety switch
- Ergonomic, soft surface
- Vibration damping



ES-Button

Flat button

Situation

Machines and systems

Solution

- ES-Button flat button

Benefits

- Simply operate by hand, foot or with the arms
- Sturdy configuration for use in a contaminated and/or wet environment, or when subject to severe mechanical stress

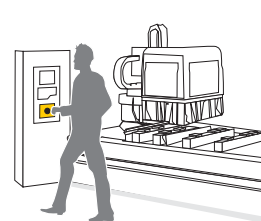

Safety mats

ESM-52/54 safety mat – standard shapes: select L x W

Various sizes

The ESM-52 is available in eight different standard sizes (rectangular). The rectangular ESM-54, which is available with an active grip structure or with a smooth surface, can be used for special intermediate sizes. Both types can be laid both directly on the ground and under a floor covering such as a carpet.



Mat types ESM-52/54

You will find general technical data on safety mats as well as accessories on the last page.

ESM-52D

Surface with grip pads

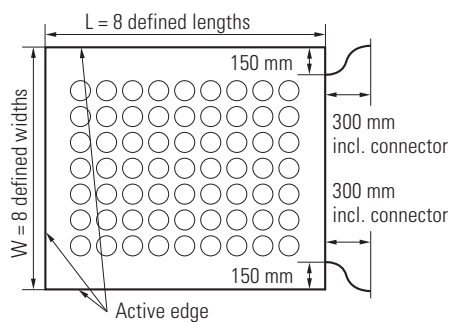

ESM-54

Surface with grip pads

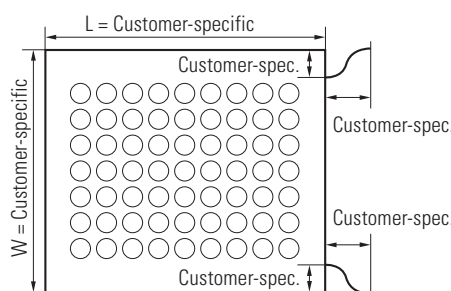

Types

- Length x width Customer-specific/
8 defined sizes
- Thickness Active grip structure 11.4 mm
Without structure 10 mm
- Weight Active grip structure 11.5 kg/m²
Without structure 10.5 kg/m²
- Number of cables 2
- Cable length 300 mm (ESM-52) or
customer-specific (ESM-54),
max. 5 m
- Cable position 150 mm from edge (ESM-52),
Side as shown in drawing, or
customer-specific (ESM-54)
- No-load resistance > 10 Mohm
- Active switching edges 3 (ESM-52) or
customer-specific (ESM-54)
- Surface See last page

Ordering information ESM-52

Type:	ESM-52D
Dimensions:	211708 ESM-52D-1000X1000 211712 ESM-52D-1200X500 211713 ESM-52D-1200X750 211710 ESM-52D-1200X1000 211711 ESM-52D-1200X1250 211715 ESM-52D-1600X500 211716 ESM-52D-1600X750 211714 ESM-52D-1600X1000
Cable position:	see graphic

Ordering information ESM-54

Type:	ESM-54 with structure (A or D) or ESM-54G (smooth surface)
Dimensions:	Length x width max. 1600 x 1000 mm or max. 1200 x 1200 mm; other sizes on request
Cable position:	min. 10 mm from edge
Cable:	1 or 2 pcs., length, with/without plug connector AMP 6.3 mm, with/without integrated resistor

Safety mats

Safety mat ESM-57 – special shapes

Tailor-made for your requirements

Do you have a special application with individual dimension and functional requirements? The ESM-57 mat is produced in the size, shape and with the surface that you require. You also have the option to individually determine the position of the cable outlet and to integrate various active switching zones, which are highlighted in different colours.

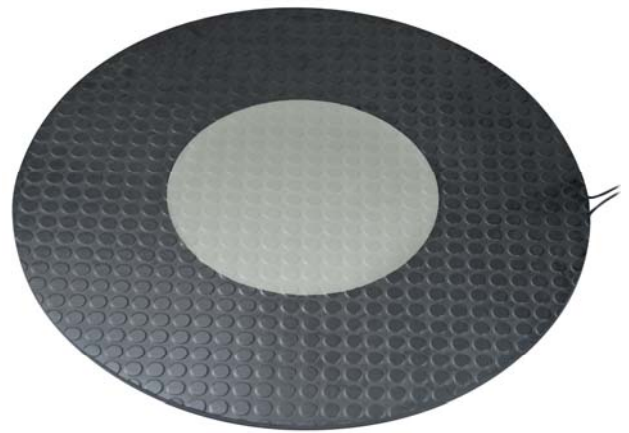

Mat types ESM-57

You will find general technical data on safety mats as well as accessories on the last page.

ESM-57

Surface with grip pads (or without structure)

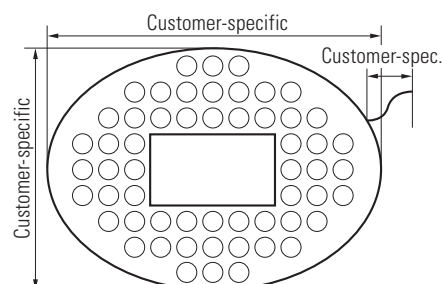
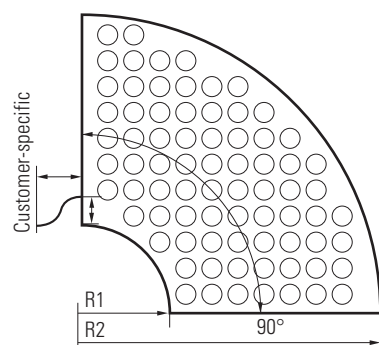

Types

- Length x width Customer-specific
- Thickness Active grip structure 11.4 mm
Without structure 10 mm
- Weight Active grip structure 11.5 kg/m²
Without structure 10.5 kg/m²
- Number of cables Customer-specific
- Cable length Customer-specific
(max. 5 m)
- Cable position Customer-specific
- No-load resistance Customer-specific
- Active switching edges 0–3
- Surface and colours See last page

Safety mats are specifically adapted and produced according to your requirements. Our specialists will be happy to offer individual advice.

Forklift mats

Sensor mat for presence detection

Developed for use on electrically driven vehicles

The EMP mat is installed on the standing platform of the vehicle and is primarily a surface switch that detects the presence of a person. The vehicle is stopped if the driver leaves the standing platform. This avoids serious accidents, injury to people and damage to property. It is therefore impossible to drive the vehicle from outside the operator's position in vehicles which are not designed for such a function, thereby guaranteeing safe vehicle operation.



ESM-Presence mat types

You will find general technical data on safety mats as well as accessories on the last page.

EMP

Surface with grip pads (also without structure)

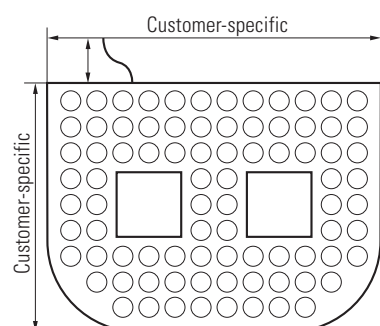
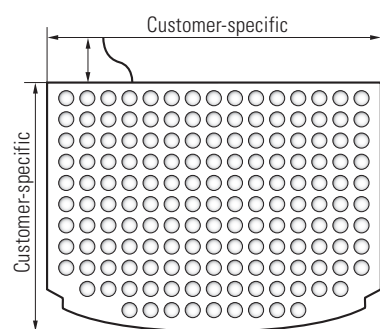

Types

The EMP forklift mats are specifically developed and tailor-made in line with your requirements.

This means that the outline, dimensions, surface structure, mat strength, hardness, size and position of additional switching zones, as well as the number and position of cable outlets are freely configurable in many areas.

The cable connections can be fitted with the plug connectors of your choice. The customer-specific surface offers an optimum and therefore secure grip. The soft mat offers protection against harmful vibrations, safeguarding the driver's health. In combination with presence detection, additional zones for foot-switch functions can be integrated into the EMP forklift mats and highlighted in different colours.

Thanks to the tailor-made solution, the mat is adapted perfectly to your industrial truck. Our specialists will be happy to offer individual advice.

ES-Button

ES-Button flat button

Application

ES-Button is a flat button used to control different machine functions. Regardless of whether a door is to be opened by an impulse, or an application is to be started, ES-Button is the interface between man and machine.

Benefit

Mounted horizontally or vertically, it can be easily actuated by hand, foot or arm. The extremely robust design allows it to be used in a contaminated as well as in a moist environment, where it is subject to heavy mechanical loads.

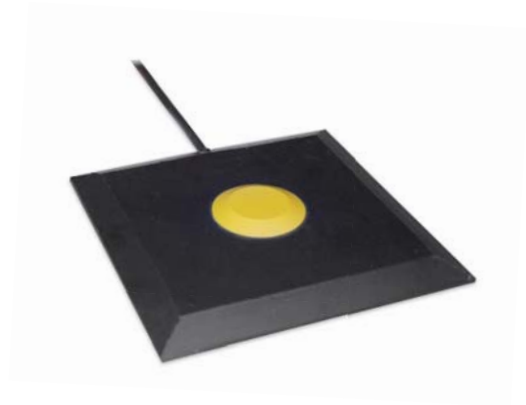

ES-Button

Dimensions

in mm

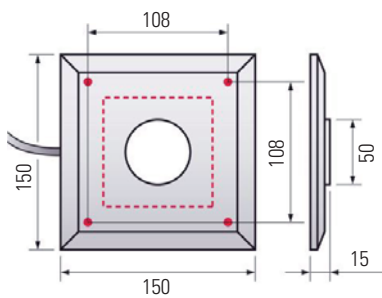

- Active switching zone
- Marking for the mounting hole (max. 6 mm diameter)

Activation options

- By hand

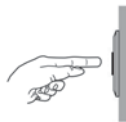

- By foot



- By arm



Technical data

■ Dimensions	150 x 150 x 15 mm
■ Material	Polyurethane black/yellow
■ Weight	0.25 kg
■ Application temperature	+5°C to +50°C
■ Protection class	IP 67
■ Loading capacity	48 V, 0.1 A
■ Response power	35 N (typical)
■ Response travel	0.5 mm
■ Switching contact	Potential-free NO contact
■ Cable type	DM cable 2 x 0.5 mm ²
■ Cable length	5 m

Ordering information

Article no.	Designation
210970 ES-Button 150 x 150	ES-Button flat button with 5 m cable
211006 ES-EC-5	Extension cable 5 m
211005 ES-EC-10	Extension cable 10 m

Ordering information (supplementary articles)

Art. no.	Description
209310 ES-RR	Edge ramp, length 6000 mm or as cut section
209305 ES-ZT	Fastening rail, length 6000 mm or as cut section
210973 ES-CC	Corner piece for edge ramp
211968 ES-RC	Straight plug connector
211723 ES-MK	Fastening set for edge ramp, set of 10 pcs.
211969 ES-RE-8k2	Terminating resistor 8.2 kohm
210975 ES-CS-1150	Guide strip, L = 1150 mm
210976 ES-CS-1550	Guide strip, L = 1550 mm

Active grip structures

In the ESM-54/57, it is possible to select from the following structures:



Structure A
Ø 25 mm, distance 29.5 mm
grip pad height 1 mm



Structure D
Ø 23 mm, distance 25 mm
grip pad height 1.4 mm



Structure G
smooth surface

Colours

In the ESM-54/57, it is possible to select from the following colours:



Yellow



Orange



Grey



Black

Switching devices

See also switching devices brochure

Article no.	Description
364283	EsMatix 3 Safety switching device
364284	EsMatix 3.D Safety switching device (inverted status output)



Technical data

Safety mats

Material	Polyurethane (PUR)
Material hardness	55 ±5 Shore A / 80 ±5 Shore A
Colours	Black, Grey, Yellow, Orange
Dimensions (length x width)	– Max. 1600 x 1000 mm – Max. 1200 x 1250 mm – Min. 200 x 200 mm (smaller on request)
Manufacturing tolerances	– Length and width: +1/–1.5 mm – Thickness: ±1.5 mm – All other dimensions acc. to DIN ISO 2768-C
Ambient temperature	–25°C to +70°C (operation and storage)
Loading capacity/Vehicle capacity	– 1 x 2000 N/cm ² , – 6000 x 2000 kg on fork lift truck roll 90 mm wide, – 1 million x 1000 N with test object 80 mm acc. to standard EN ISO 13856-1, – 5 million x 750 N with test object 80 mm, mat in combination with ES switching device
Electrical loading capacity	Voltage max. 48 V ACDC Current max. 0.5 A
Response time	<5 ms, EsMatix 3 switching device
Protection class	IP 67 acc. to EN 60529 without cable ends
Insulating strength	> 1500 V AC
Cable type	2 x 0.5 mm ²
Cable length	– Standard: 300 mm, with plug connector – Customer-specific: max. 5 m, without plug connector
Composition (> 1% by weight)	– Polyurethane PUR (sealing compound) – Fibreglass epoxy resin (contact surface substrate) – Copper (contact surfaces, cables)
Standards	Bircher safety mats correspond to PL e and cat. 3 acc. to EN ISO 13849-1 and are type-tested acc. to EN 13856-1
Chemical resistance of PUR	Weather, ozone, oils, petrol, water 20°C, solvents, acids

Note

Technical details and recommendations concerning our products are based on experience and are an aid for the orientation of the user. Details stated in our brochures and data sheets do not guarantee special properties of the products. This does not apply to special product properties confirmed in writing or individually on a case-by-case basis. Subject to technical alterations.

BBC Bircher Smart Access

Wiesengasse 20
8222 Beringen
Switzerland
Phone +41 52 687 11 11
info@bircher.com
www.bircher.com