

CareMat M, Sample

The pressure-sensitive mat for supervision of people with dementia and disorientation

Product Description

CareMat is used in retirement and nursing homes as well as in hospitals and similar facilities. It is placed beside the patient's bed or by the room door exit. In both cases the CareMat is connected to the in-house nurse call system. As soon as the person leaves the bed and steps onto the CareMat, a signal is triggered via the nurse call system. This allows the personnel on duty to establish at any time of the day or night, when and where a patient got out of bed or is leaving the room. As a result, CareMat contributes to providing assistance immediately, thus significantly reducing the risk of falls or the danger of patient wandering.



Selection chart

	CareMat	M	0	1	T	E868
▪ Dimension code						
A						
B						
C						
M						
▪ Colour code						
0						
1						
▪ Case code						
1						
▪ Type code						
E						
C						
P						
T						
▪ Transmitter type code						
B434						
E868						
L433						
L869						

Features

- Dimensions 283 x 202 mm
- Hard-wired and wireless versions
- A robust and reliable alarm sensor
- Hygienic: Easy to clean and resistant to bodily fluids

Content

- 1 Product description
Selection chart
Features
- 2 Model list
Technical specifications
- 3 Technical specifications
CareMat dimensions
Case dimensions
- 4 Technical specifications
CareMat dimensions
Case dimensions
- 5 Product details

CE The texts of the EU Declaration of Conformity are available at the following address:
<https://smartaccess.bircher.com/en/downloads-bbc-bircher-smart-access/>

Model list

Product		Colour	Part number	Description
CareMat	M01E	Careyellow	303411	283 x 202 mm, sample / empty housing
	M11E	Caregrey	357834	
CareMat	M01C	Careyellow	303389	283 x 202 mm, sample / cable
	M11C	Caregrey	357833	
CareMat	M01P	Careyellow	307499	283 x 202 mm, sample / universal PCB with cable
	M11P	Caregrey	357838	
CareMat	M01T B434	Careyellow	303412	283 x 202 mm, sample / TeleAlarm radio transmitter 434.01 MHz
	M11T B434	Caregrey	357836	
CareMat	M01T E868	Careyellow	303414	283 x 202 mm, sample / ELDAT radio transmitter 868.30 MHz
	M11T E868	Caregrey	357837	
CareMat	M01T L433	Careyellow	336677	283 x 202 mm, sample / Lehmann radio transmitter 433.92 MHz
	M11T L433	Caregrey	357839	
CareMat	M01T L869	Careyellow	336679	283 x 202 mm, sample / Lehmann radio transmitter 869.2125 MHz
	M11T L869	Caregrey	357840	

Technical Specifications

Characteristics

CareMat General

Dimensions	Surface: 283 x 202 mm x 9.5 mm / height standard case 1: 14.5 mm
Weight	0.6 kg
Material	Polyurethane PU
Colour	Careyellow / Caregrey
Surface	Nub structure with sloped edges
Person activation weight	Min. 10 kg
Chemical resistance	Water, bodily fluids, commercially available disinfectants, max. 70 % vol. alcohol
Protection class	IP54, dust- and splash-proof
Temperature range	0 to +55 °C

CareMat versions with cable

CareMat M01E / M11E

Connection	This CareMat can be equipped by cable or various transmitters.
EC-Conformity	RoHS 2011/65/EU

CareMat M01C / M11C

Cable	Length 3 m, diameter 5.2 ± 0.2 mm, cable colour white
Cable type	4-wire, LiYYv 4 x 0.34 mm ² , wire colours BN/YE/GN/WH, open cable head
Cable as spare part	According to above specifications available, part number 307131
Signal output	Normally open contact (NO)
Admissible capacity	Max. 50 mA at 48 V AC/DC

CareMat M01P / M11P

Cable	Length 3 m, diameter 5.2 ± 0.2 mm, cable colour white
Cable type	4-wire, LiYYv 4 x 0.34 mm ² , wire colours BN/YE/GN/WH, open cable head
Cable as spare part	According to above specifications available, part number 307131
Signal output	Normally open contact (NO) or resistance monitoring (acc. to VDE 0834)
Operating voltage	3-24 V DC
Operating current	Max. 25 mA

Functionalities universal PCB The CareMat M01P / M11P (P = circuit board) includes a universal circuit board in the housing. The universal circuit board can be adapted to your needs by altering the switch positions. The wiring on the universal circuit board must not be removed. The connections are protected against wrong polarity of input voltage.

Variable resistance R

The universal circuit board has two connector sockets for commercially-available wired resistors. A call resistor that is specifically for the call system for line monitoring can be installed in this. The connecting wiring should have a diameter between 0.38 and 0.56 mm. The socket spacing should be 14 mm.

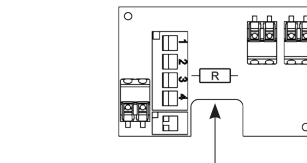

NC contact

The NC (normally closed) contact option, which can be selected on the universal PCB, is a transistor circuit. It operates according to the quiescent current principle. If the CareMat is not actuated, a quiescent current flows through the NC contact as a result of the externally applied voltage. If the resident / patient actuates the CareMat by stepping on it, this NC contact is opened. This can be detected by a nurse call system operating according to the quiescent current principle that monitors the current flow.

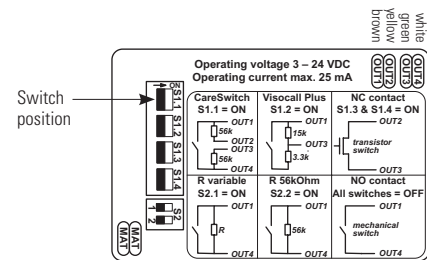

CareMat wireless versions

CareMat M01T B434 / M11T B434

Radio transmitter	TeleAlarm, 1 channel, unidirectional
Radio frequency	434.01 MHz, TeleAlarm protocol
Radio range	up to 30 m in buildings, dependent on structural building conditions (up to 250 m in free field)
Battery type	1 x CR2032, 3 V Lithium button cell
Battery lifetime	3 years (at 3 alarms and 1 daily test transmission)

CareMat M01T E868 / M11T E868

Radio transmitter	ELDAT, 1 channel, unidirectional
Radio frequency	868.30 MHz, EasyWave® protocol
Radio range	up to 30 m in buildings, dependent on structural building conditions (up to 250 m in free field)
Battery type	1 x CR2032, 3 V Lithium button cell
Battery lifetime	2 years

CareMat M01T L433 / M11T L433

Radio transmitter	Lehmann electronic VarioRec®, 1 channel, unidirectional
Radio frequency	433.92 MHz, VarioRec® protocol
Radio range	up to 30 m in buildings, dependent on structural building conditions (up to 100 m in free field)
Battery type	1 x CR2032, 3 V Lithium button cell
Battery lifetime	3 years
Battery monitoring	Battery low message

Characteristics

CareMat M01T L869 / M11T L869

Radio transmitter	Lehmann electronic VarioRec®, 1 channel, unidirectional
Radio frequency	869.2125 MHz, VarioRec® protocol
Radio range	up to 30 m in buildings, dependent on structural building conditions (up to 100 m in free field)
Battery type	1 x CR2032, 3 V Lithium button cell
Battery lifetime	3 years
Battery monitoring	Battery low message

CareMat Dimensions

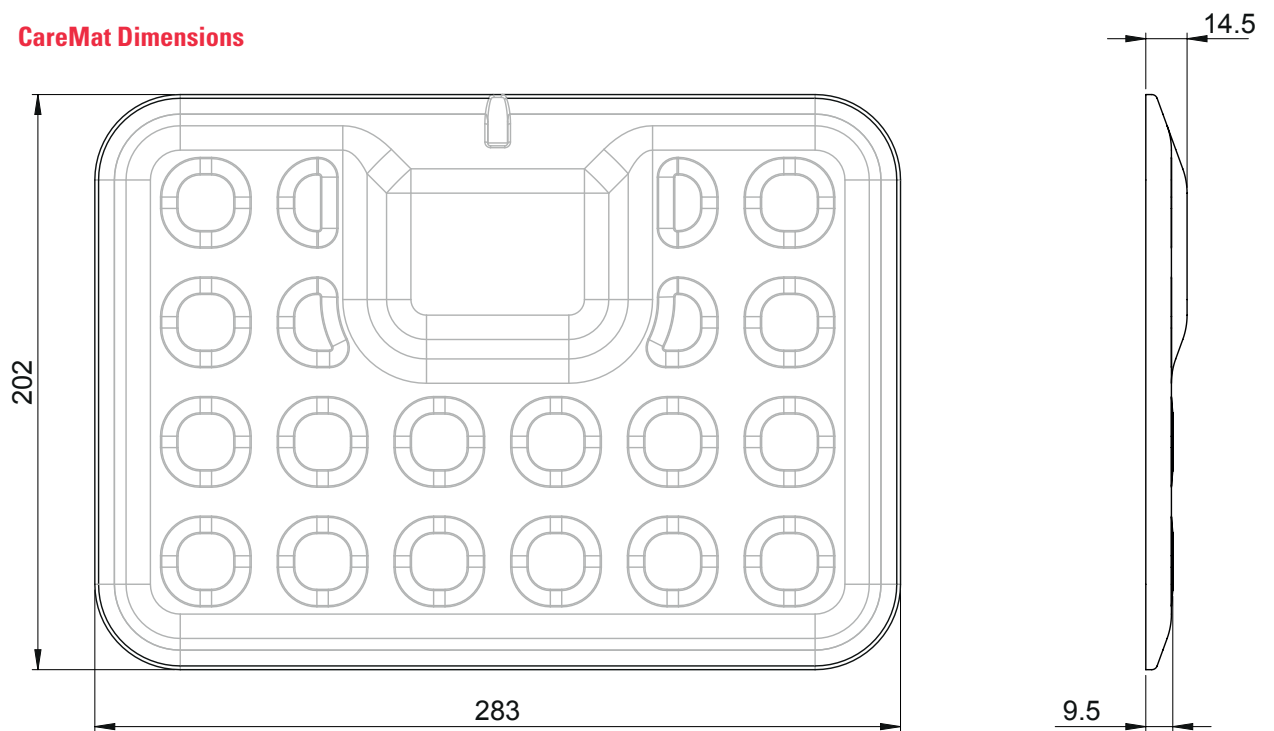

Case Dimensions (Standard)

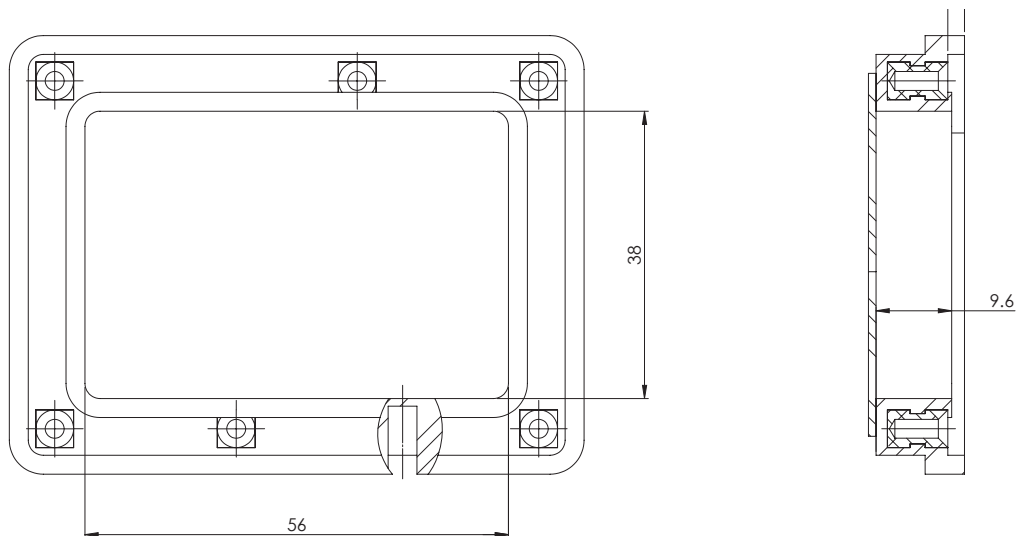

Product Details

Front

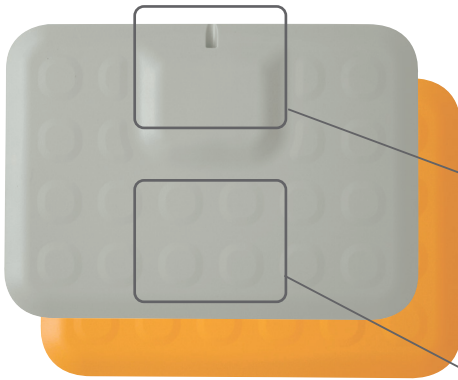

Multifunctional case

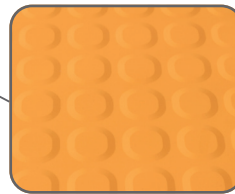

Non-slip surface design

Back

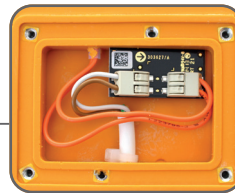
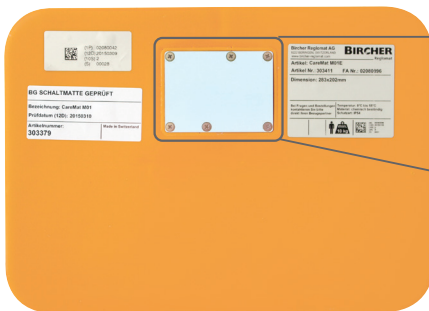

Cable connection

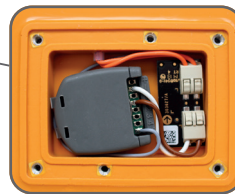

Transmitter placement

Packaging



Find out more about the product online
www.caremat.ch

